

**206-T20-\_\_**

Trim Kit Only for Thermostatic Valve with Built-In Control

For use with SS-TH2000, SS-TH4000 or SS-THVD2 concealed rough with built-in control

Note: For use with SS-THVD3 concealed rough, S1 or V trim must be specified

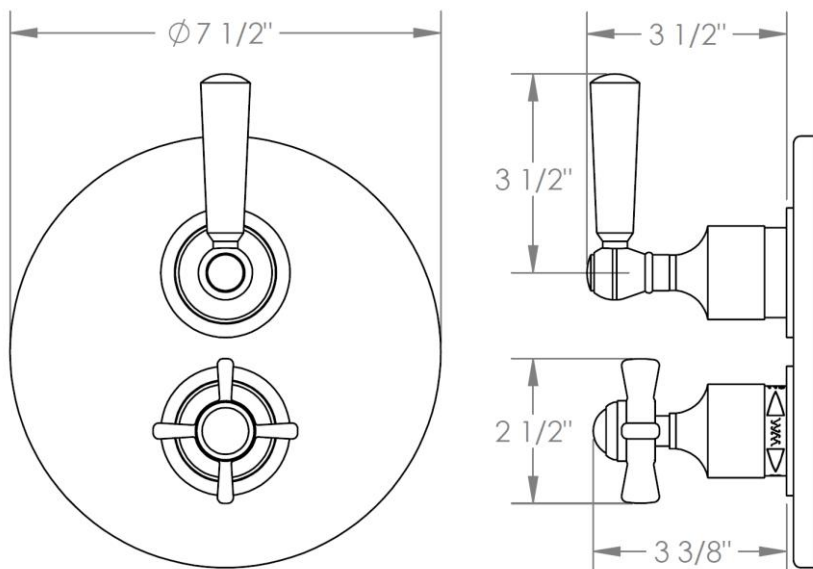

HANDLE TRIM OPTIONS

S1 - PRESTON

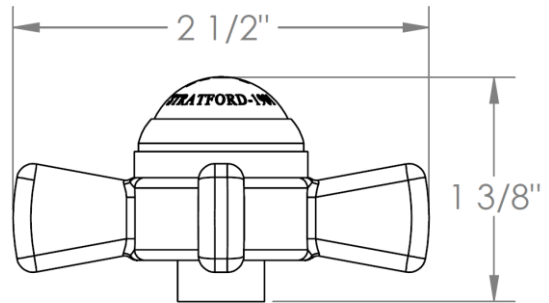

S2 - WALTHAM

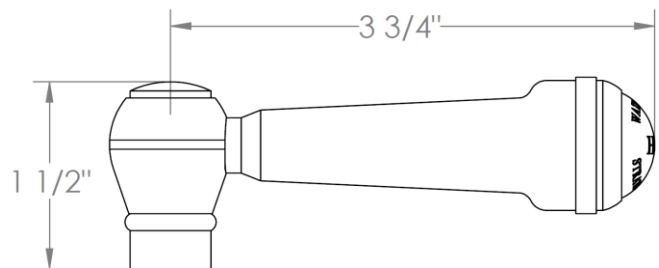

SWA - DARIEN

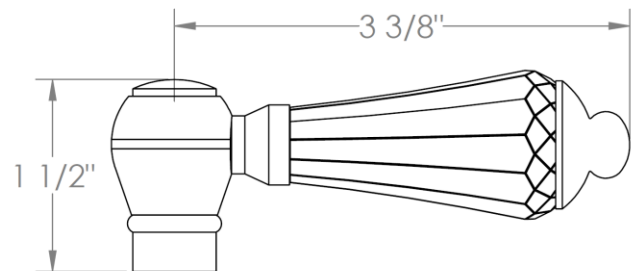

V - WALES

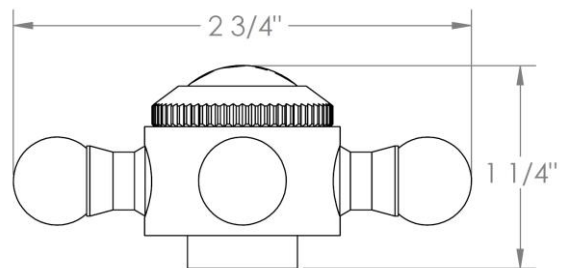

S1A – NOTTINGHAM

