

27-2-CL14

Deck Mounted 3 Hole Lavatory Set
Includes MPU7 pop-up drain
Flow Rate: 1.2 GPM

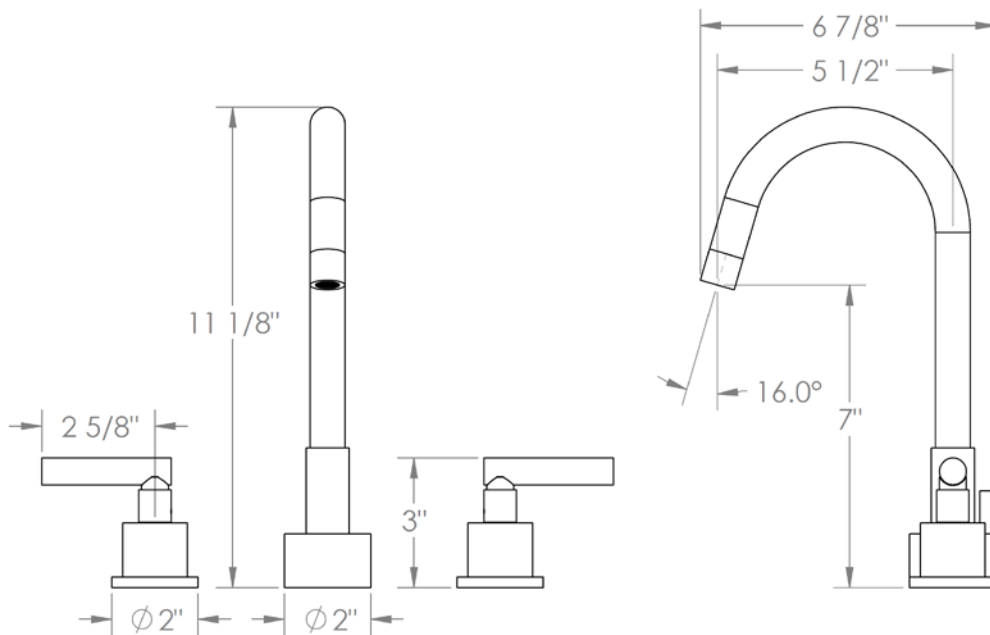

Meets the applicable requirements of ASME A112.18.1-2005/CSA B125.1-05, entitled "Plumbing Supply Fittings"

WATERMARK DESIGNS 5/24/2018

350 Dewitt Ave Brooklyn NY 11207 USA T 718 257 2800 F 718 257 2144 info@watermark-designs.com