

Brass Tub Drain Direct Outlet Lift & Turn (Two Hole) Tub Waste

Model #: 401-



FEATURES:

- FITS MOST MANUFACTURERS' TUBS 14"-16" DEEP
- 6" SHOE LENGTH with direct outlet
- 1 1/2" IPS course thread brass Gerber style shoe elbow
- 2 screw blank faceplate with toe control stopper
- Lift & turn drain plug
- 1 1/2" O.D. 17 gauge brass tubing
- All brass construction
- Overflow height & shoe length can be cut to size (if required)

AVAILABLE FINISHES:

Polished Chrome (PCH)	Satin Chrome (SC)	Bronze Umber (BU)
Satin Nickel (SN)	Pewter (PEW)	Caramel Bronze (CB)
Polished Nickel (PN)	Antique Brass (AB)	Antique Copper (ACU)
Oil-Rubbed Bronze (ORB)	Polished Brass (PB)	Polished Copper (PCU)
Vintage Bronze (VB)	Satin Brass (SB)	Rose Gold (RG)
Matte Black (MBK)	Satin Gold (SG)	Polished Gold (PG)
Black Nickel (BKN)	Bombay Gold (BG)	Jewelers Gold (JG)
Europa Bronze (EB)	White (WH)	Sedona Beige (SDB)
Tristan Brass (TB)	Unlacquered Brass (ULB)	Satin Cooper (SCU)

SPECIFICATION DRAWING:

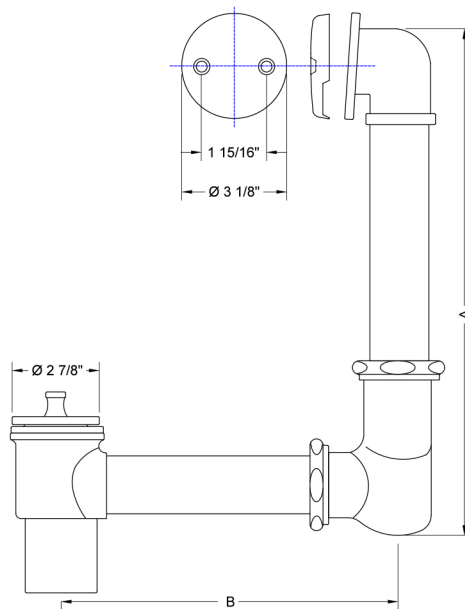

	401-	402-	403-
A	14"-16"	17"-26"	17"-26"
B	6"	10"	10"